

MI CUADERNO DE LETRAS

M T S

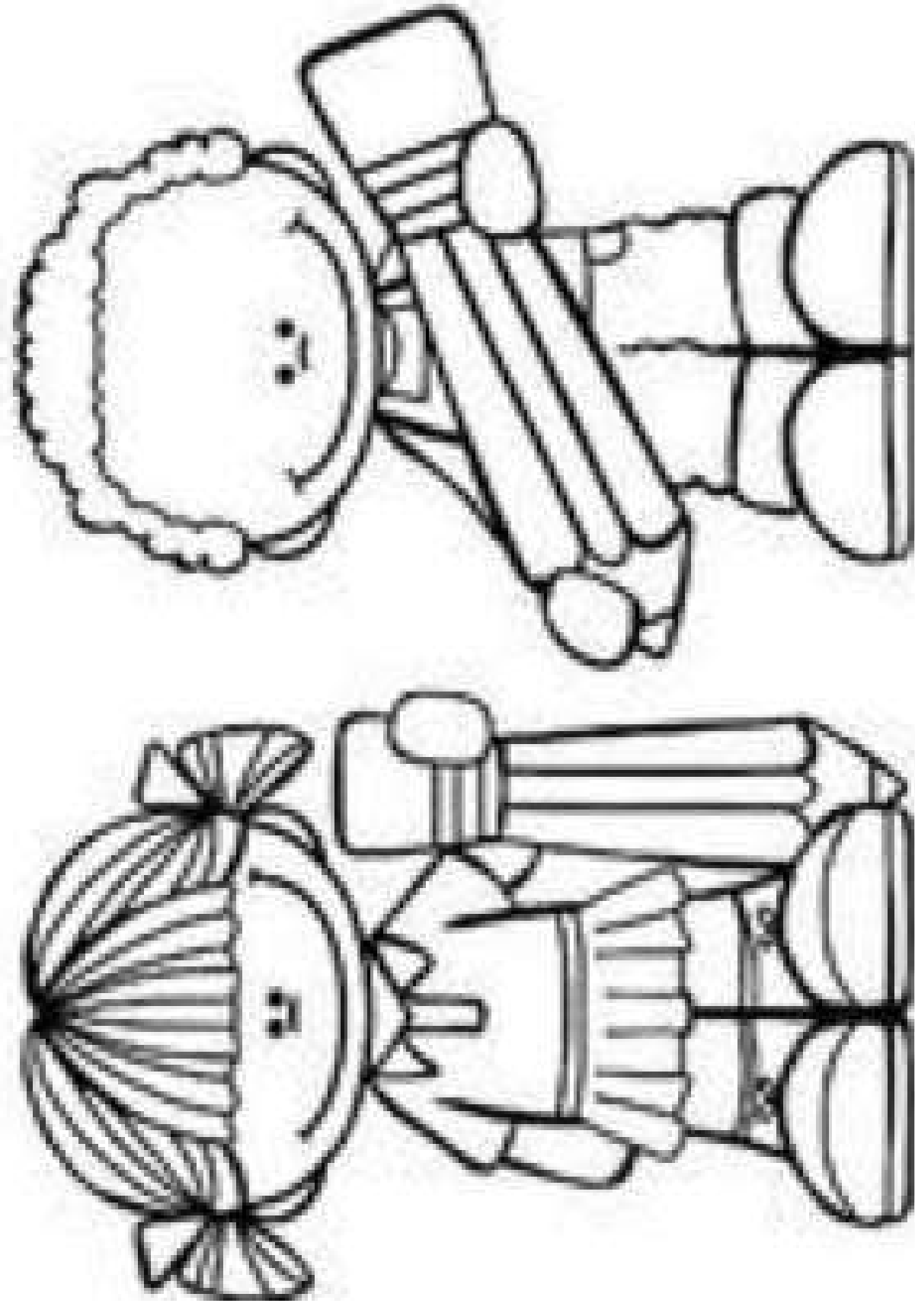

Nombre _____ 2º trimestre

5 años. C.E.I.P. Remigio Laín

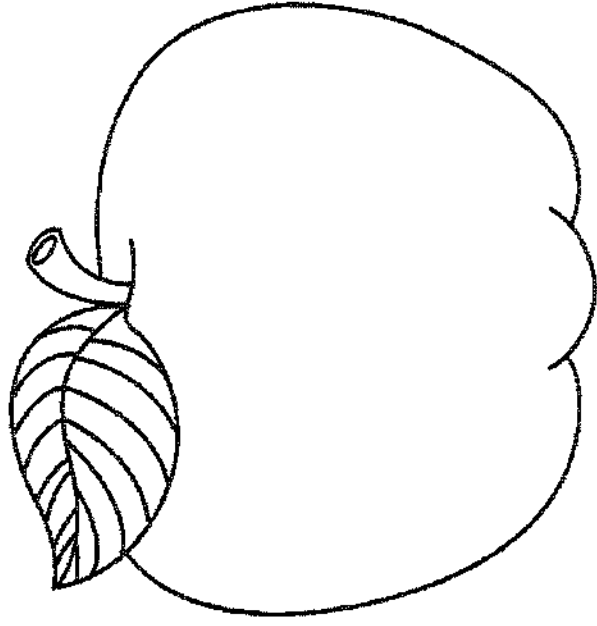

MANZANA

El libro de la letra M, m.

NOMBRE:

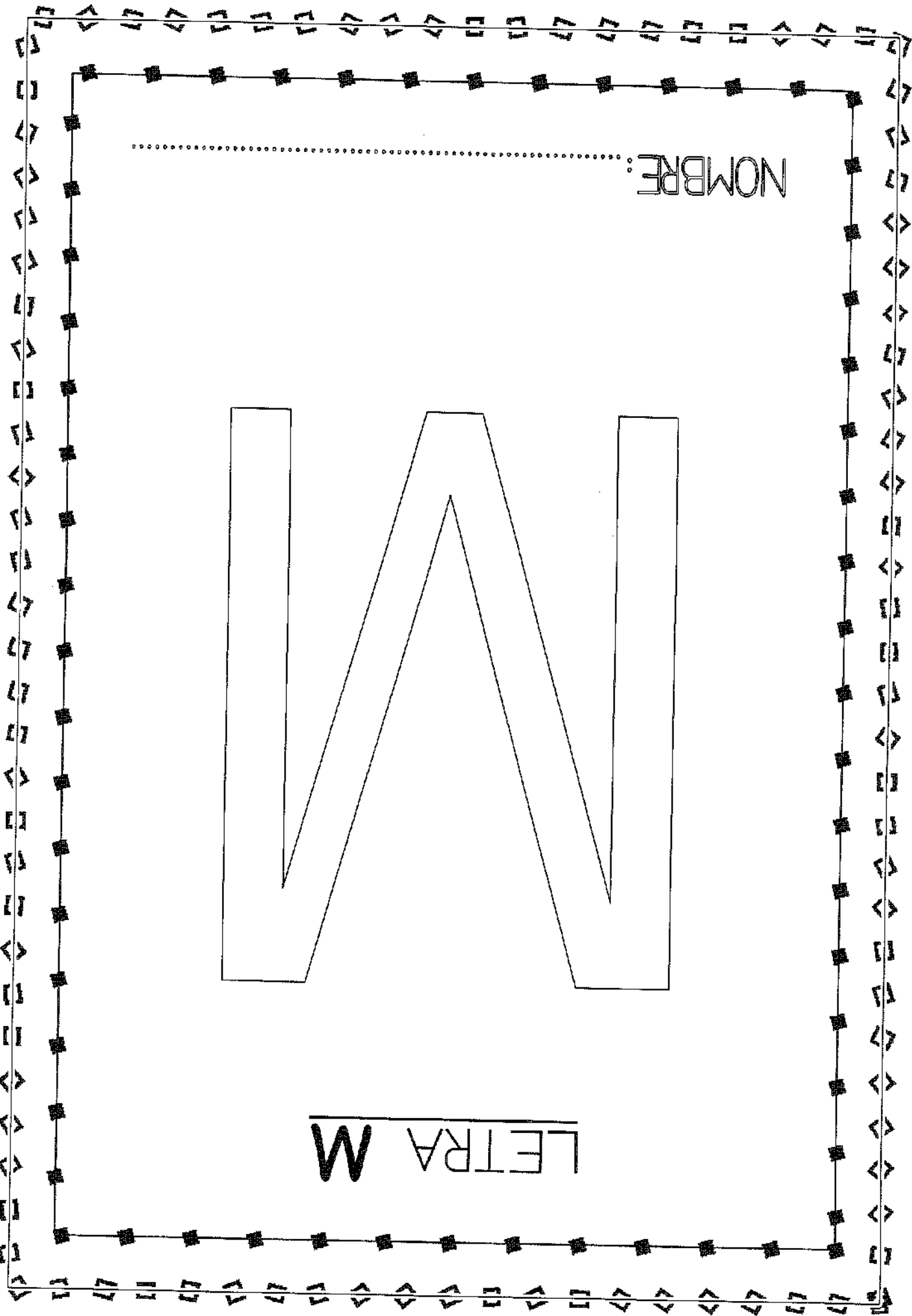

NOMBRE:

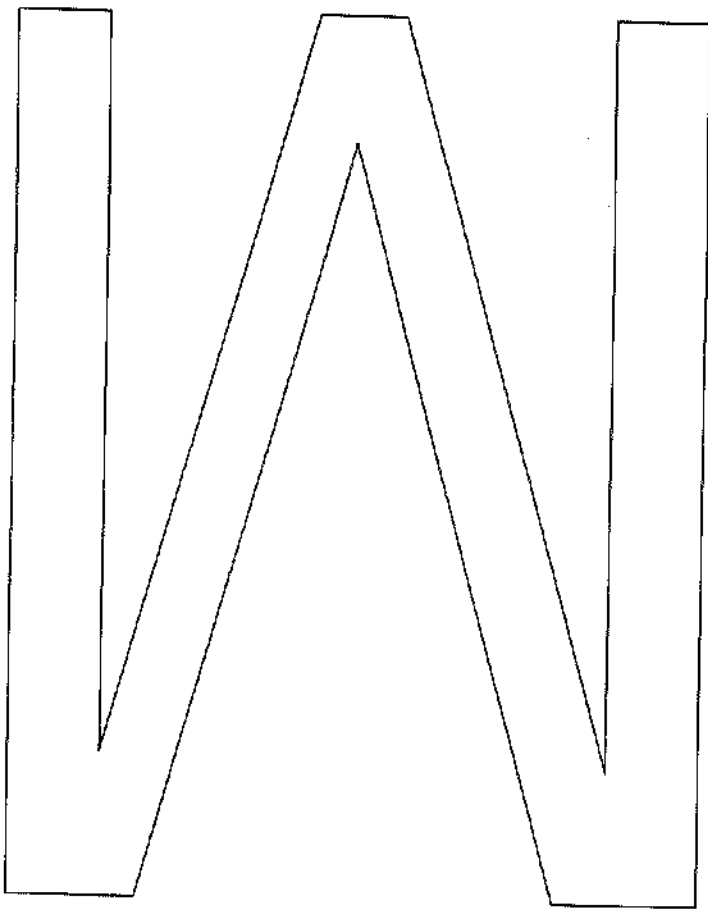

LETRA M

COLOREA LA LETRA **M**

M

L

A

M

S

L

M

A

M

T

NOMBRE:.....

Colorea las imágenes que contienen la letra M, m.

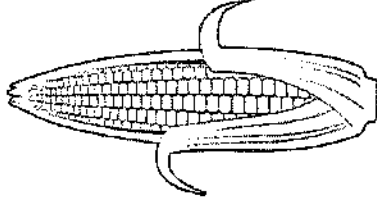
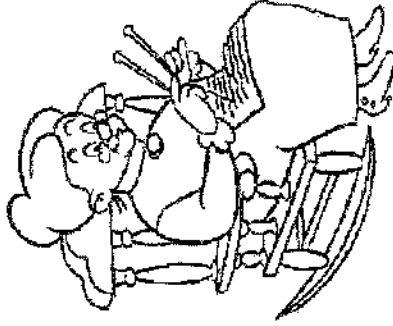
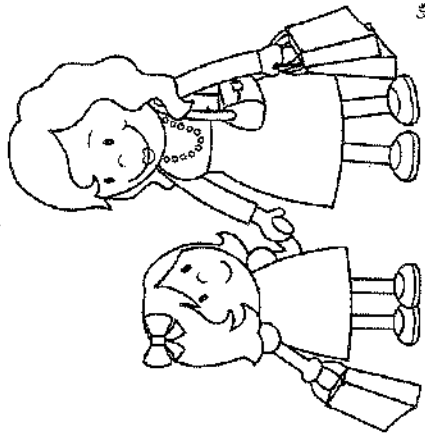
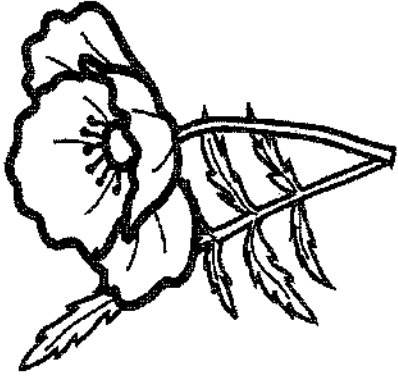
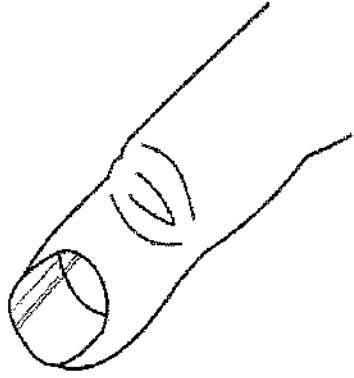
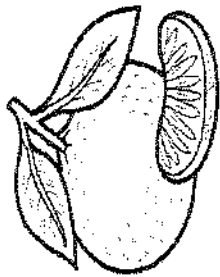

NOMBRE:.....

REPASA LA LETRA "M"

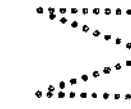
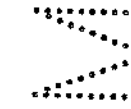
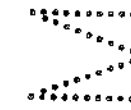
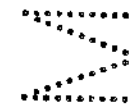
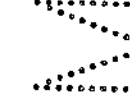
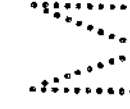
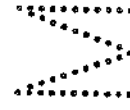
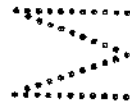
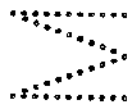
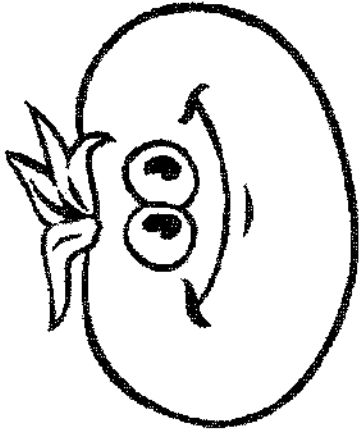
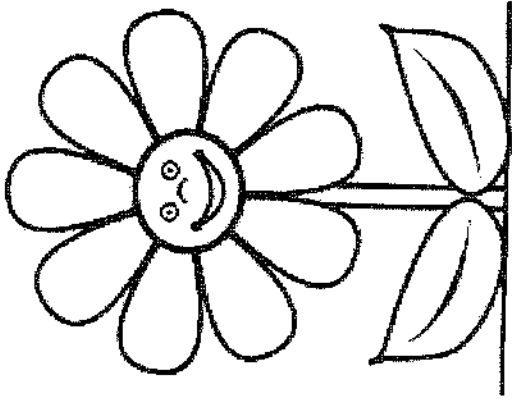
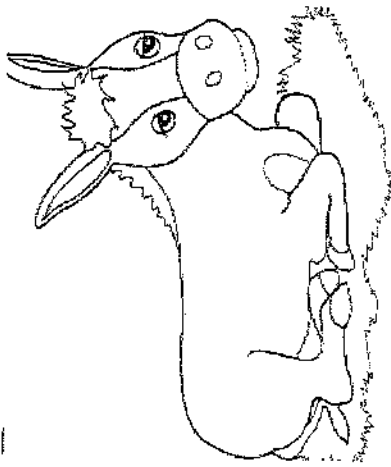

NOMBRE

Colorea los dibujos que tienen la letra M, m:

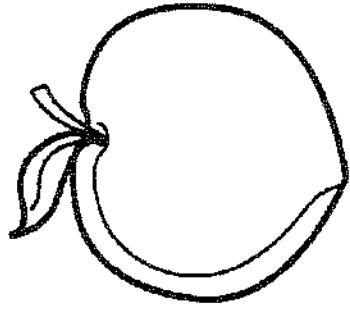
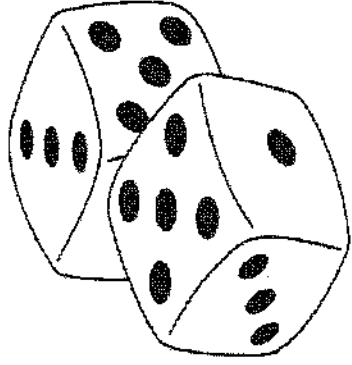
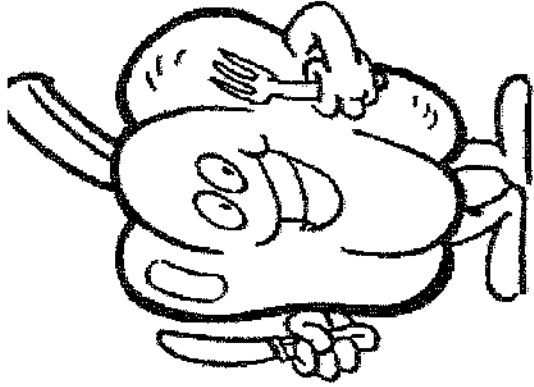

Melocotón

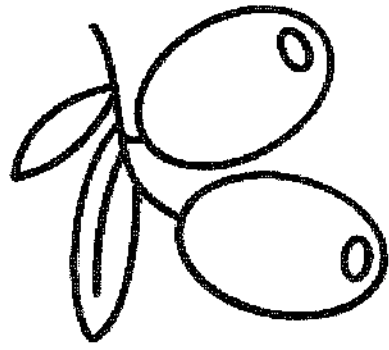

NOMBRE: _____

ESCRIBO LA LETRA "M"



DIBUJO:

NOMBRE:

REPASO Y ESCRIBO

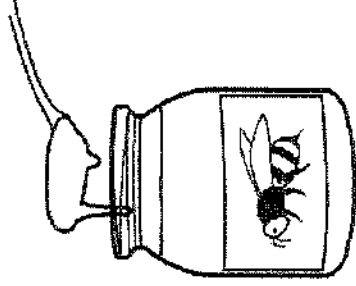
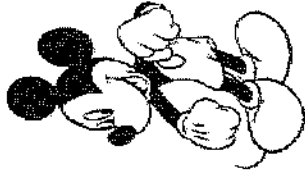
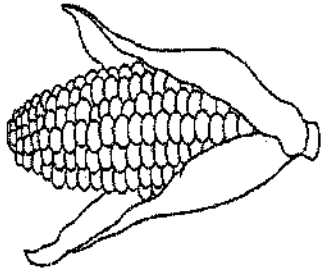





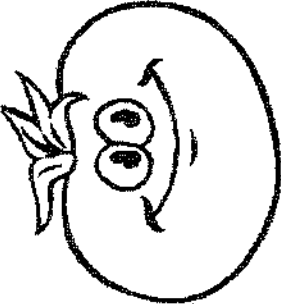
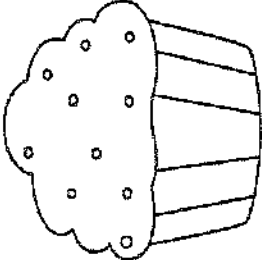

N A M E M I C K Y M O U S E

N A M E M I C K Y M O U S E

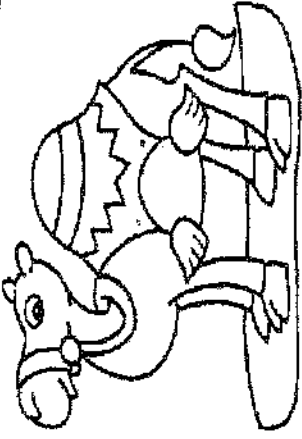

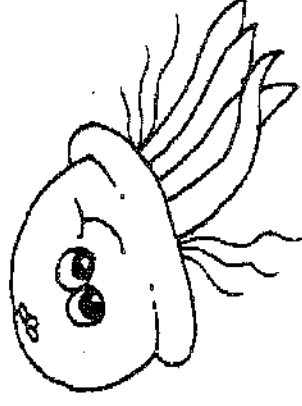
NOMBRE:

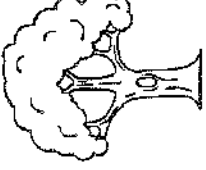
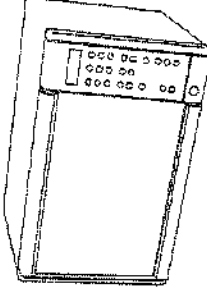
Colorea las imágenes que contengan las sílabas señaladas:

Ma			
Me			
Mi			

NOMBRE:.....

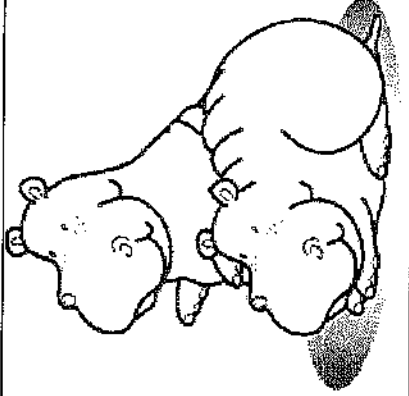
Colorea las imágenes que contengan las sílabas señaladas:

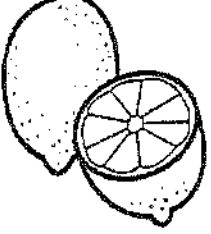
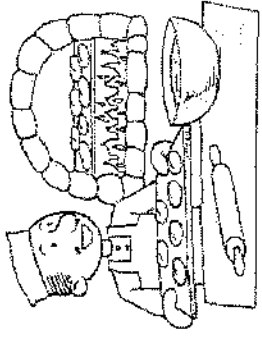
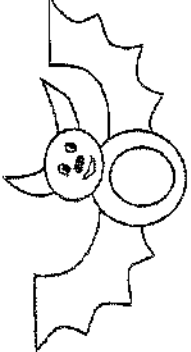
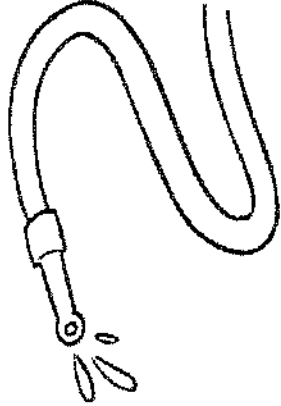
Ma			
Mu			

NOMBRE:.....

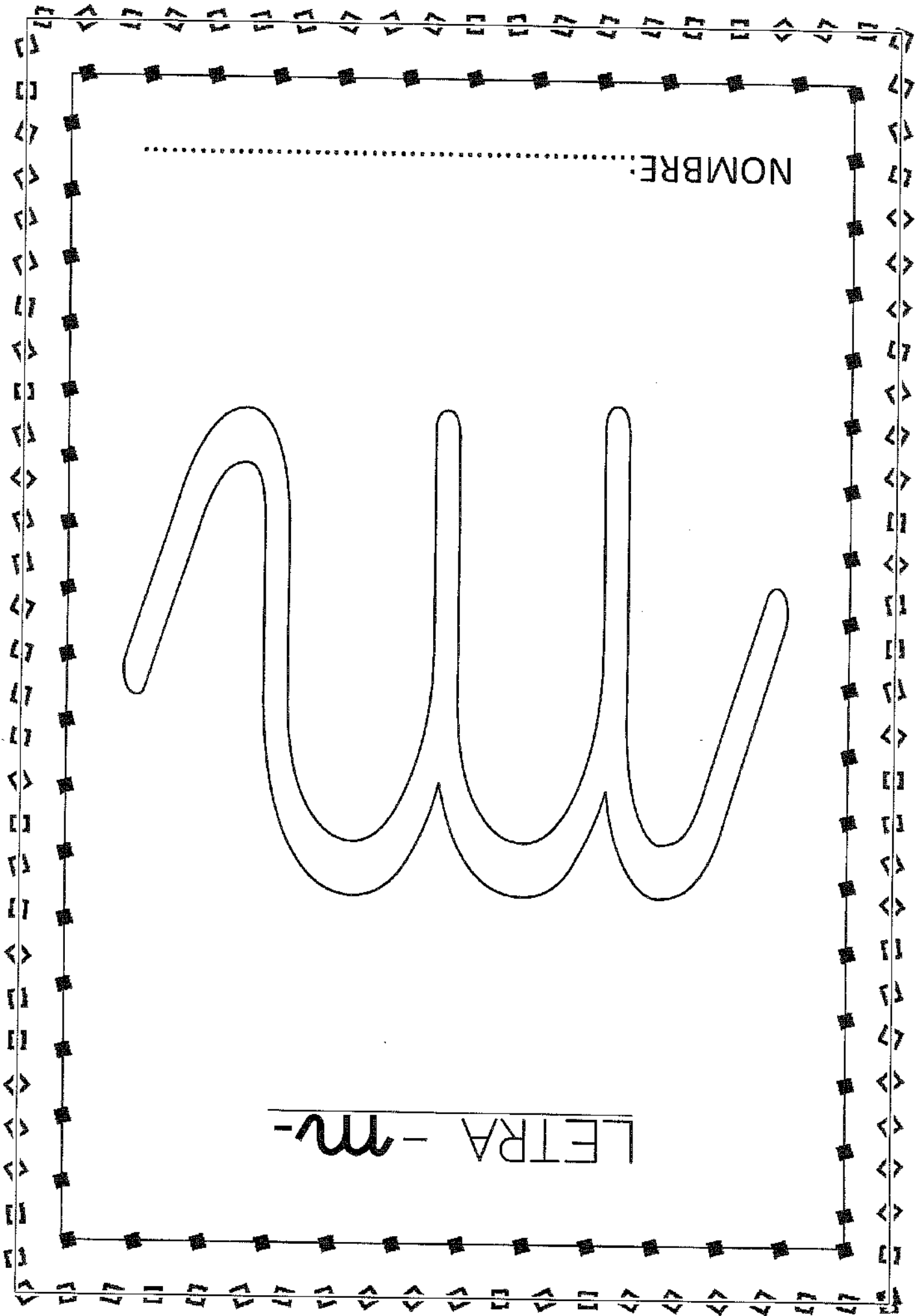

NOMBRE:

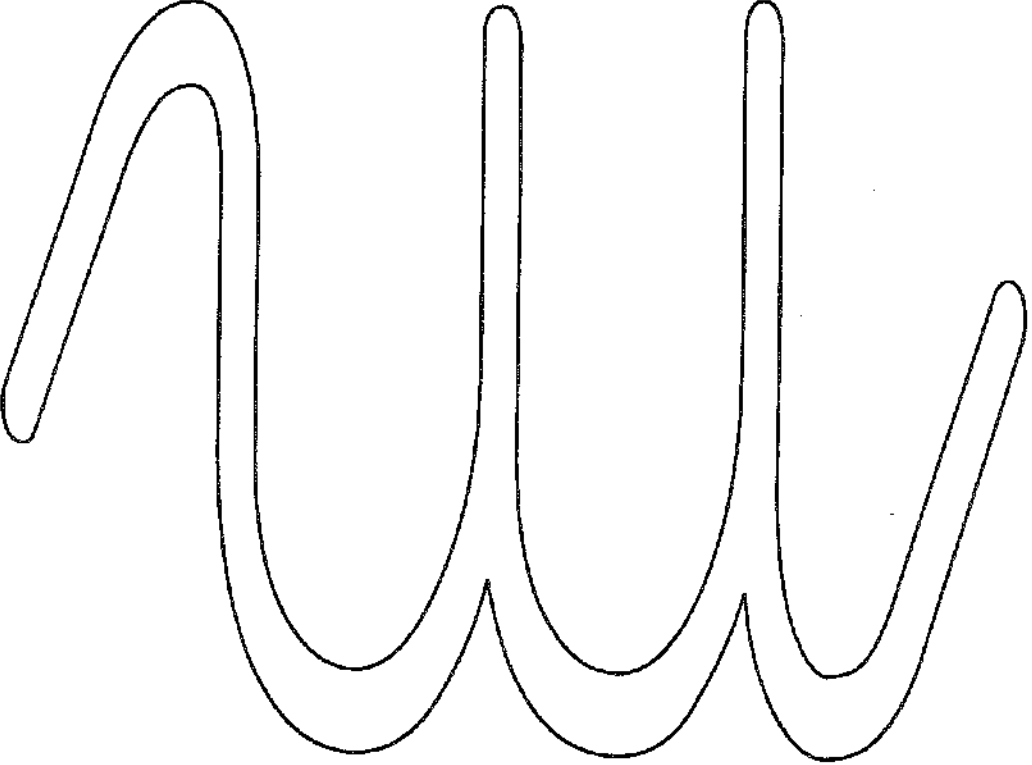

LETRA - m -

COLOREA LA LETRA -m-

e

m

m

a

l

a

m

l

m

e

NOMBRE:.....

Colorea las imágenes que contengan el sonido M/m.

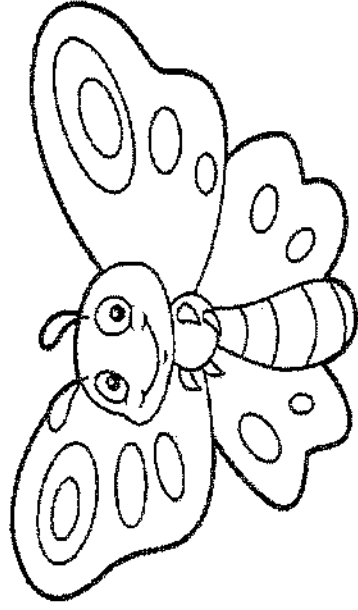

m

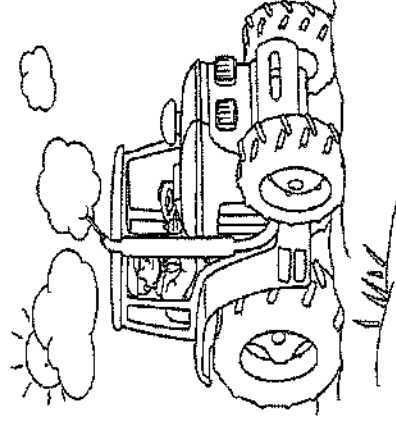
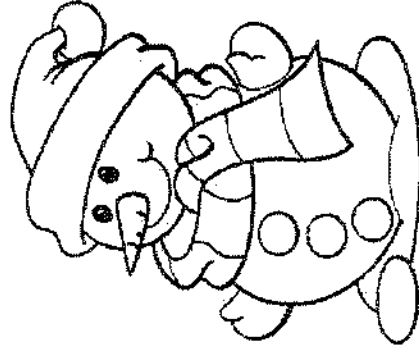

NOMBRE:.....

Rodea la "M" en rojo y la "m" en azul

M a P A m r E
V A m a m A
M m e A r E
i A g a P i M
M e r m E A

M	m
---	---



NOMBRE:

REPASA LA LETRA -m-

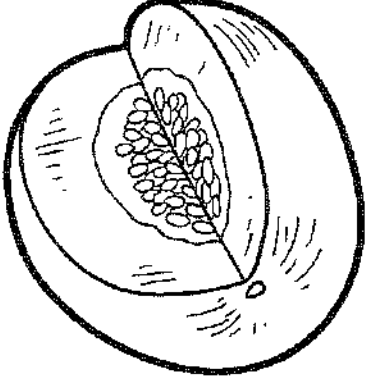
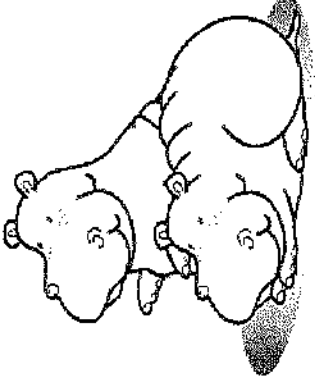
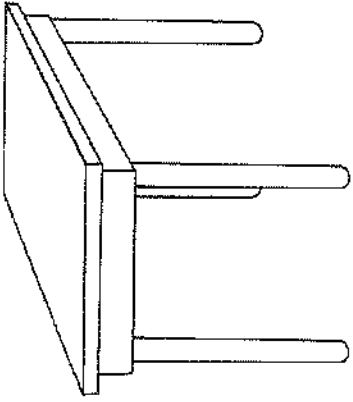

m m m m m m m m m m

m m m m m m m m m m

NOMBRE:

Busca "ma, me, mi, mo, mu"

mapa

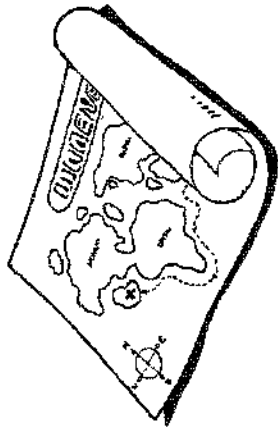

mesa

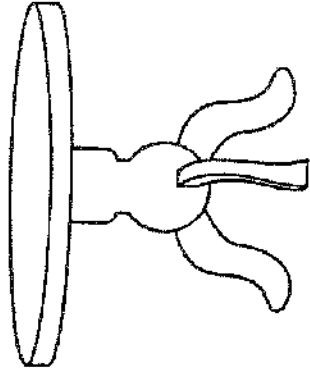

mula



familia

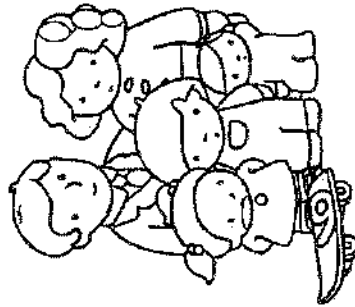

moto

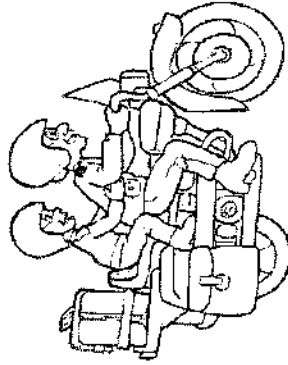

NOMBRE:

ESCRIBO LA LETRA "m"



DIBUJO:

NOMBRE:.....

REPASO Y ESCRIBO LA LETRA "m"

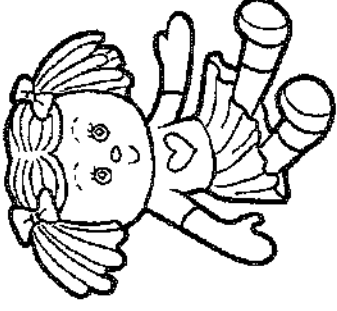

ma me mi mo my ma

ma me mi mo my ma

NOMBRE:

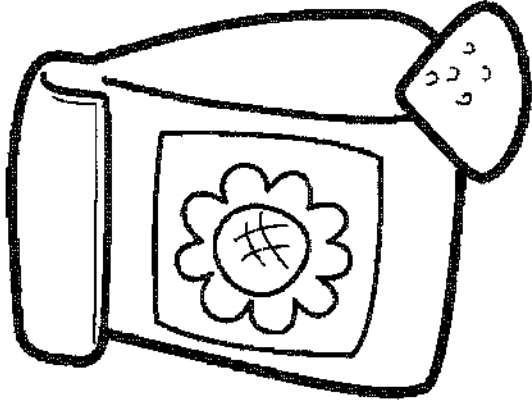

SEMILLA

El libro de la letra S, s.

NOMBRE:

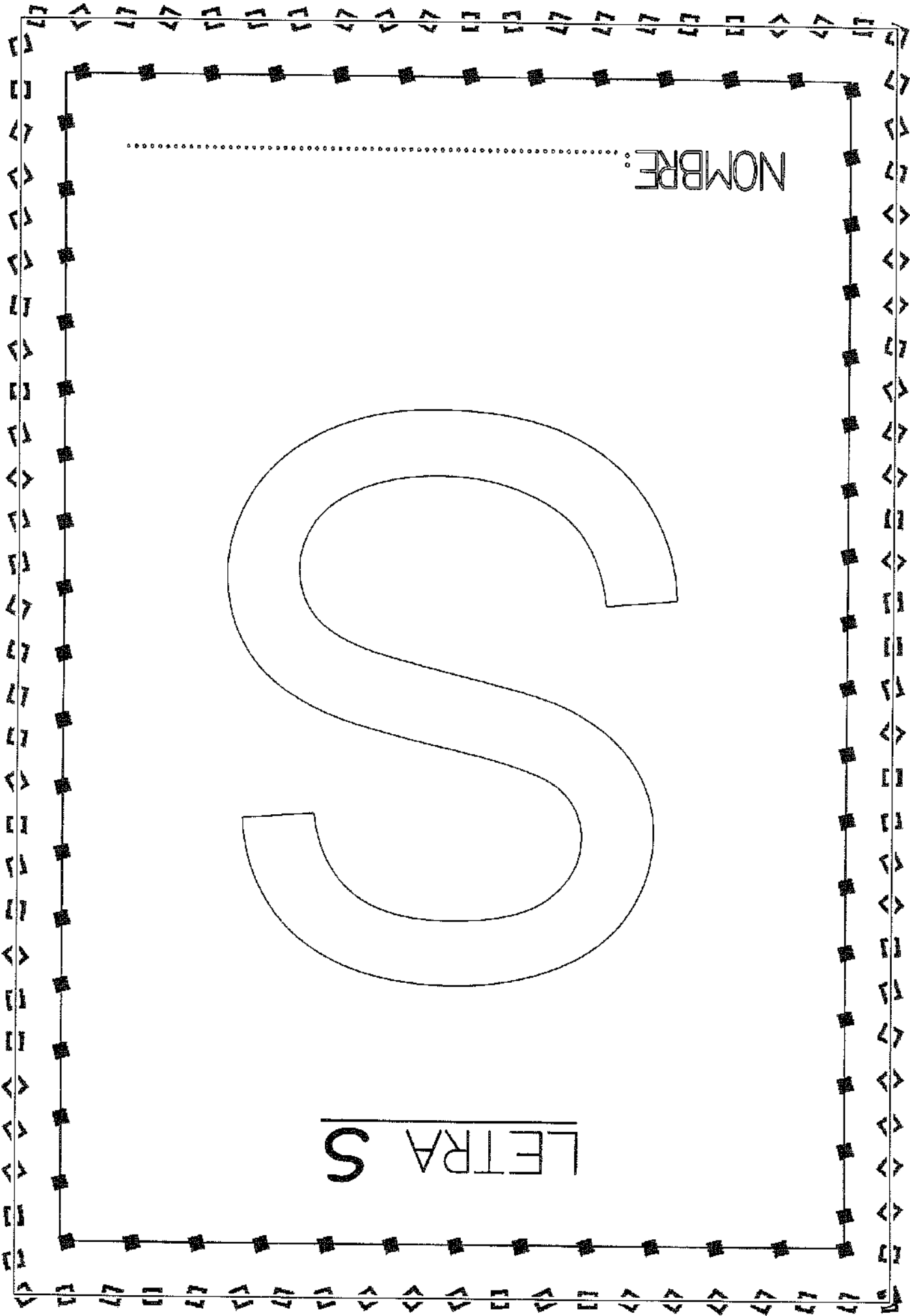

NOMBRE:

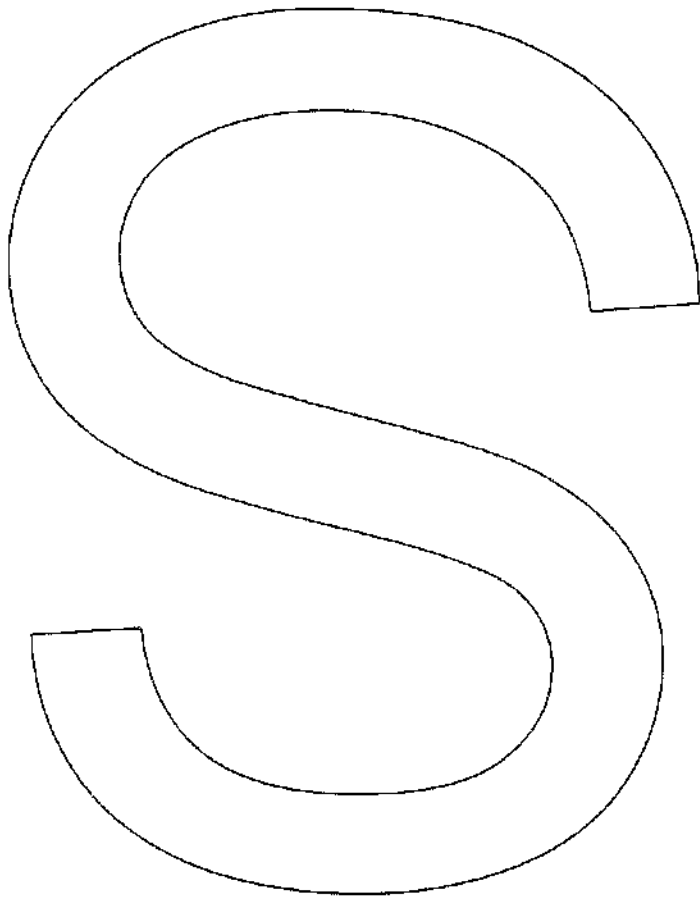

LETRA S

COLOREA LA LETRA S

S

2

M

M

T

S

A

S

S

S

L

M

P

NOMBRE:.....

Colorea las imágenes que contienen la letra S, s.

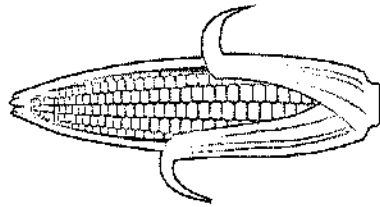
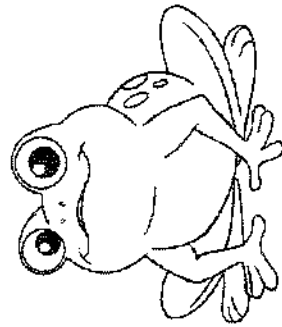
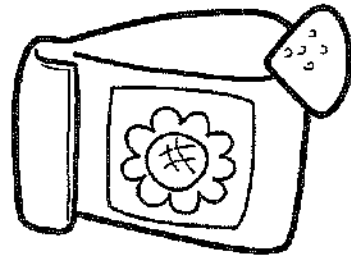
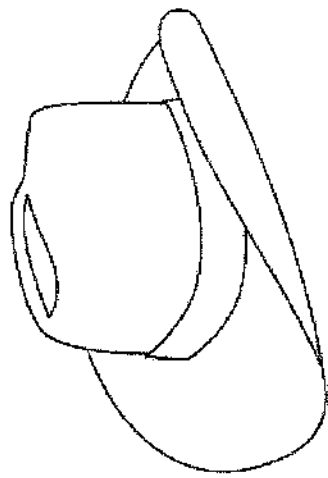
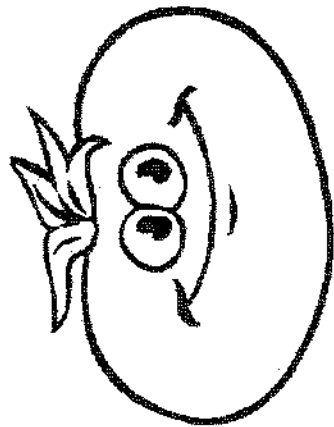
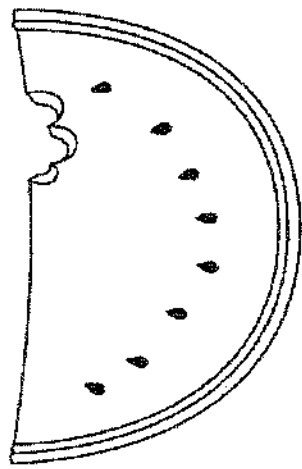

NOMBRE:.....

BUSCA LA LETRA "S"

SOMBRERO

SABOR

TRES

SEMÁFORO

SUAVE

SEMILLA

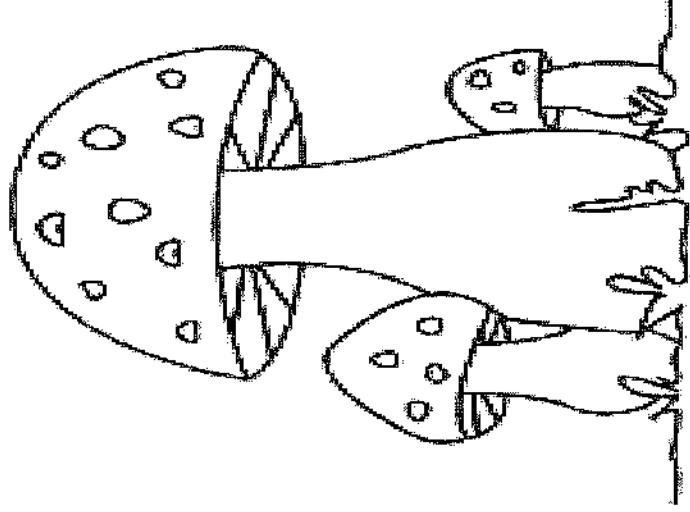

SETAS

PALAS

NOMBRE:.....

REPASA LA LETRA "S"

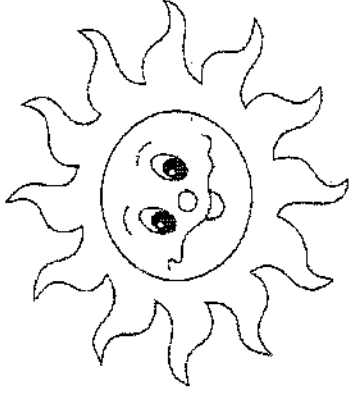
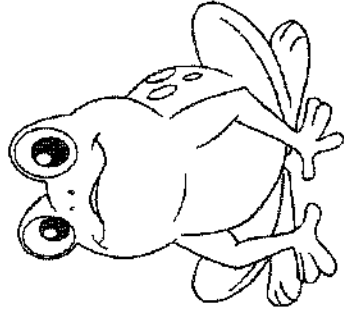
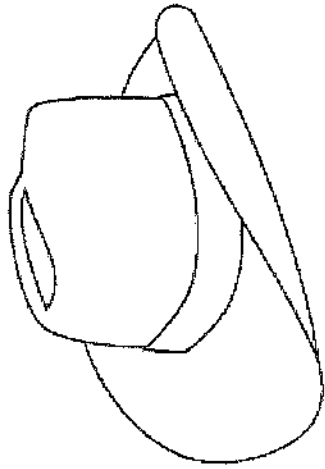

NOMBRE

ESCRIBO LA LETRA "S"



DIBUJO:

NOMBRE:

REPASO Y ESCRIBO

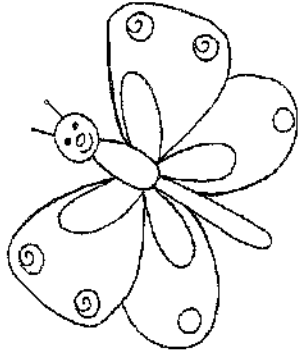
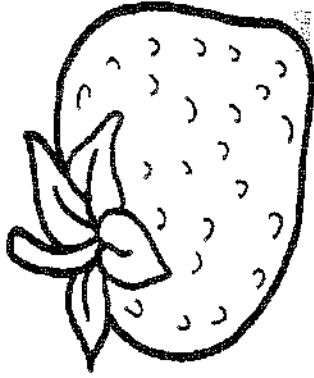
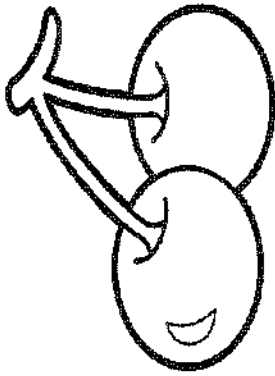





S A S F S J S O S U S A S F S I S

S A S F S J S O S U S A S F S I S

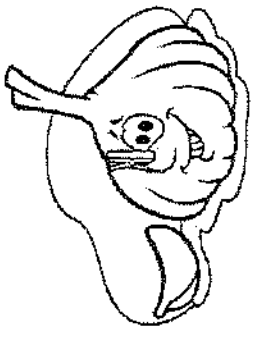
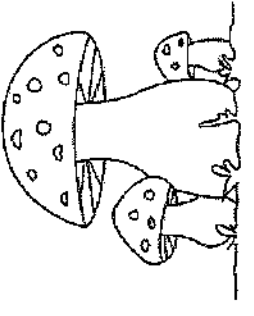
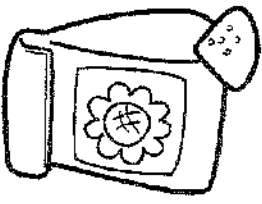
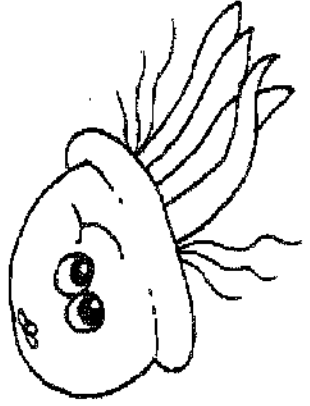
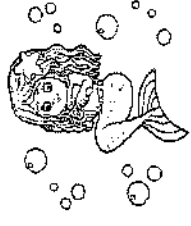

NOMBRE:

Colorea las imágenes que contengan las sílabas señaladas:

Sa			
Se			
Si			

NOMBRE:.....

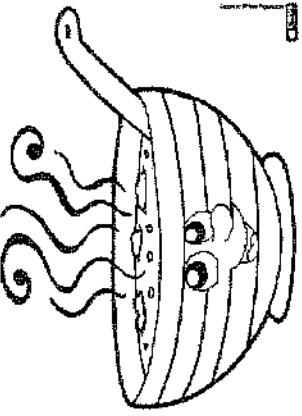
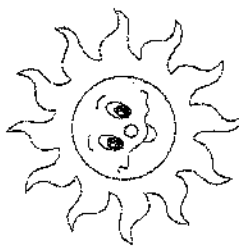
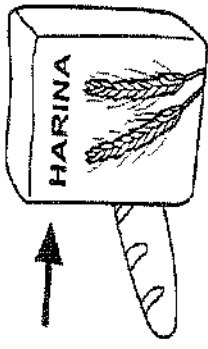
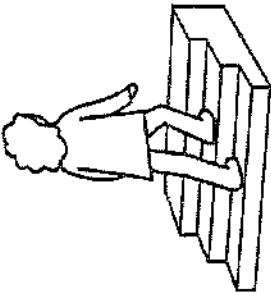
Colorea las imágenes que contengan las sílabas señaladas:

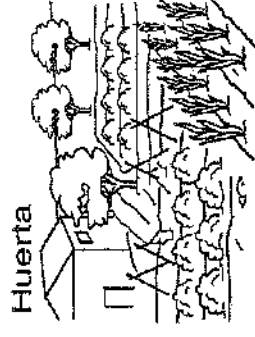
So			
Su			

NOMBRE:.....

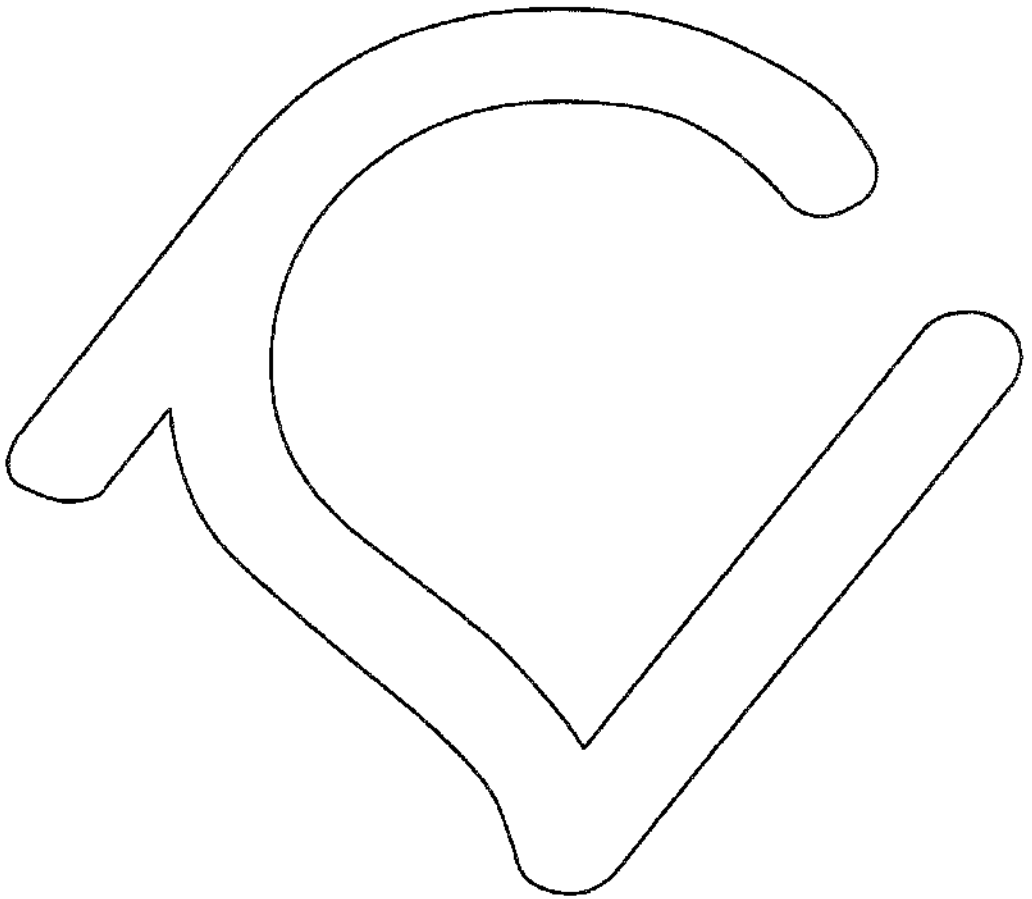

NOMBRE:

LETRA - 2 -

COLOREA LA LETRA -D-

t

d

d

d

d

j

m

d

n

a

d

a

l

d

NOMBRE:.....

Colorea las imágenes que contengan el sonido S/s.

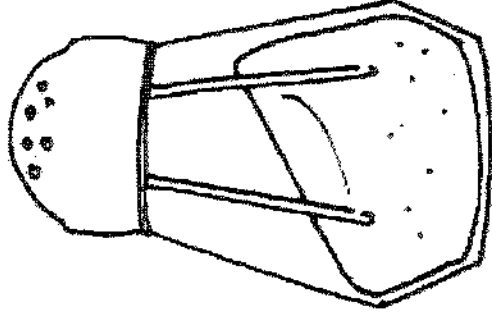
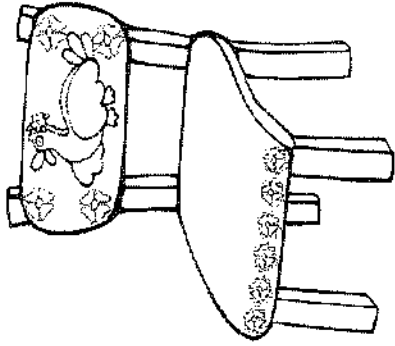

S

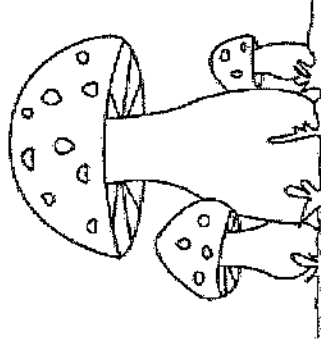
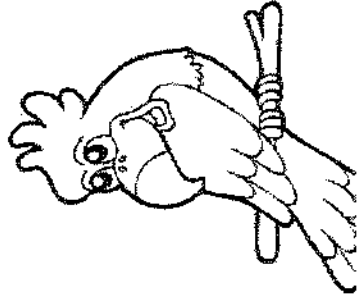

NOMBRE:.....

BUSCA LA LETRA "s"

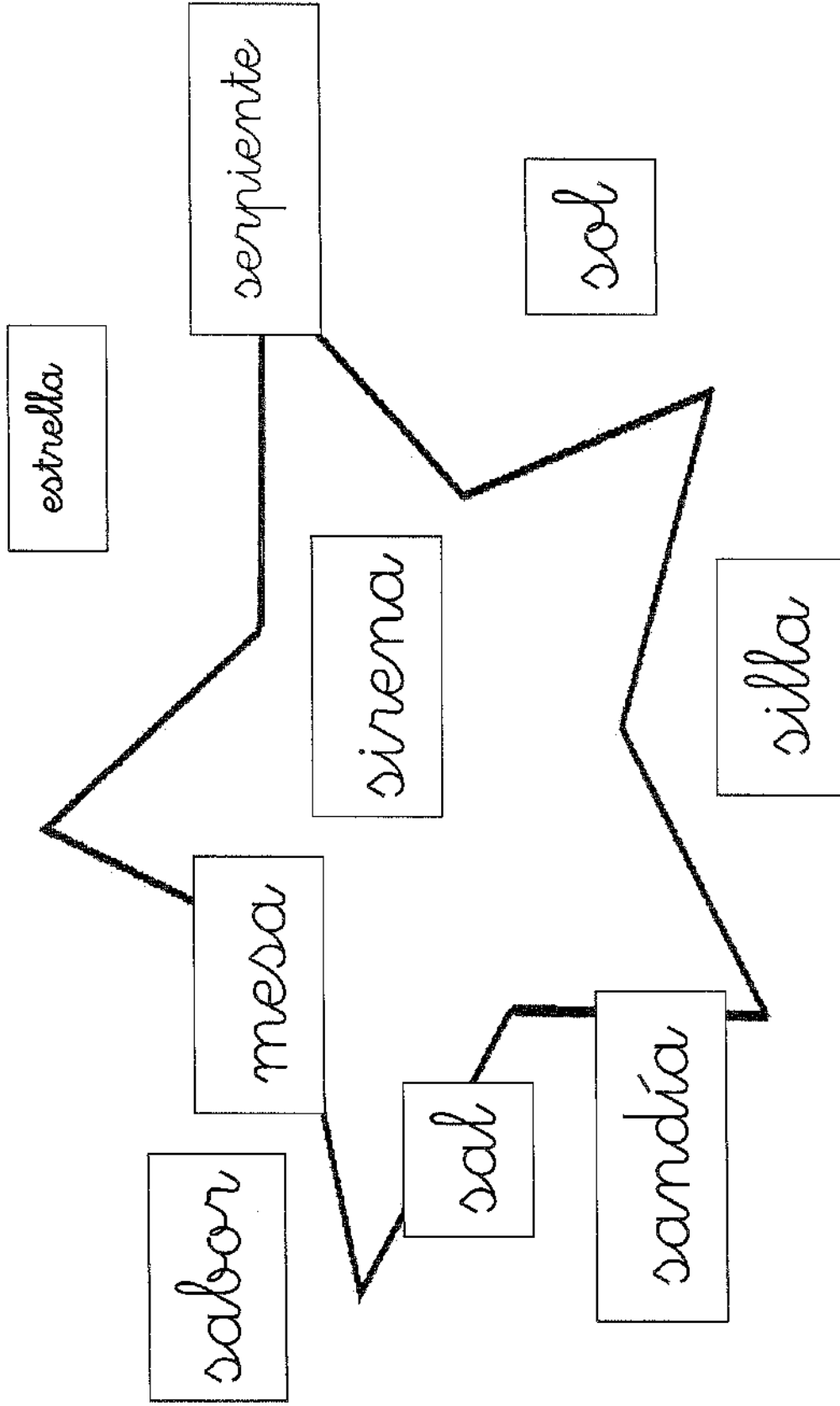

NOMBRE:.....

Colorea los dibujos que tienen la letra S, s:

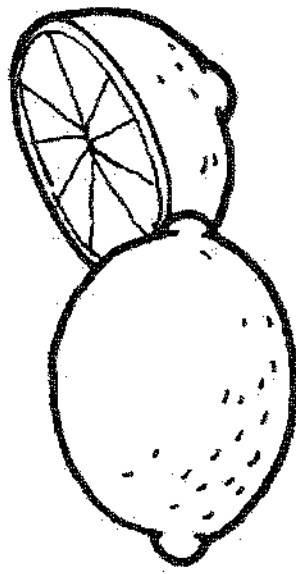
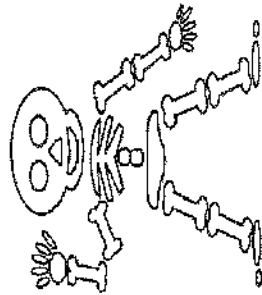
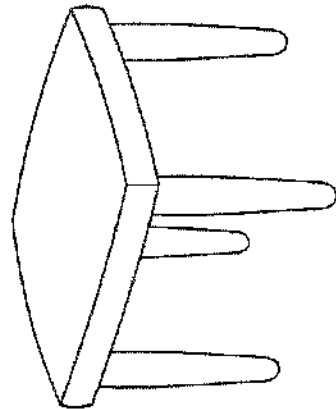
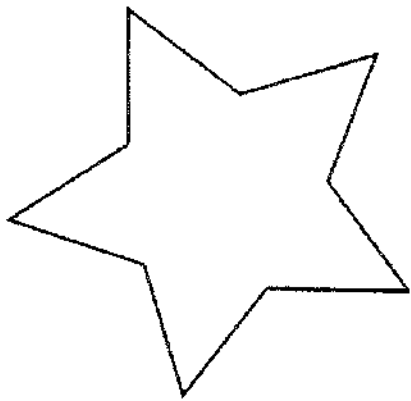
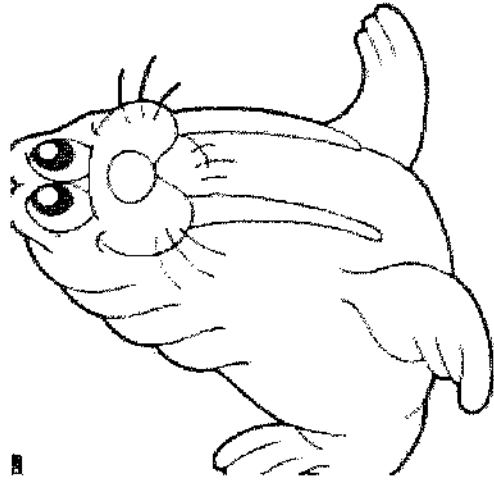

NOMBRE: _____

REPASA LA LETRA -O-

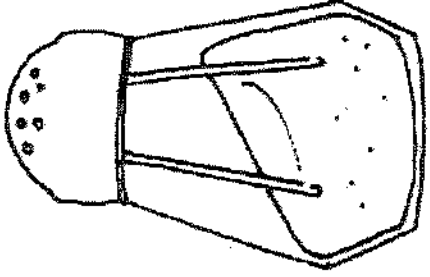
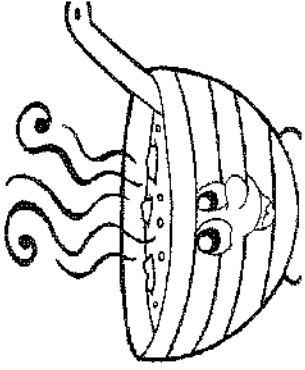
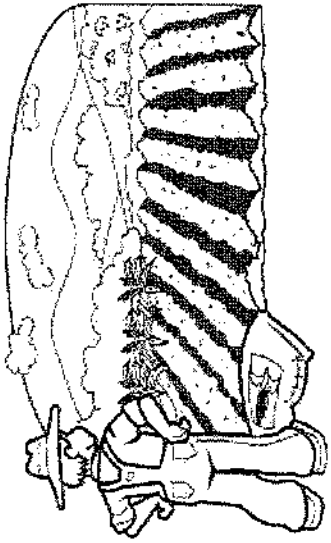

NOMBRE:

.....

ESCRIBO LA LETRA "o"



DIBUJO:

NOMBRE:

REPASO Y ESCRIBO LA LETRA "O"

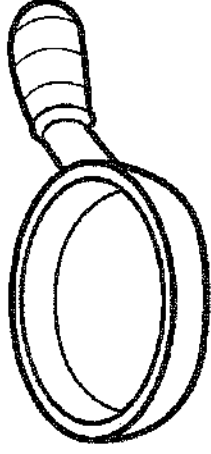
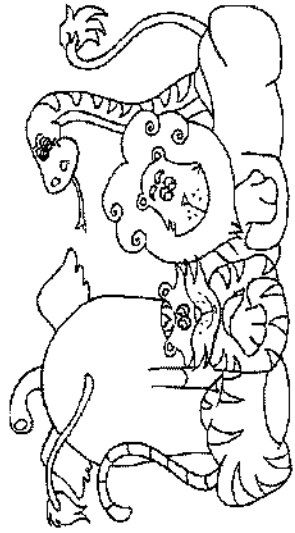

o o

o o

NOMBRE:

.....

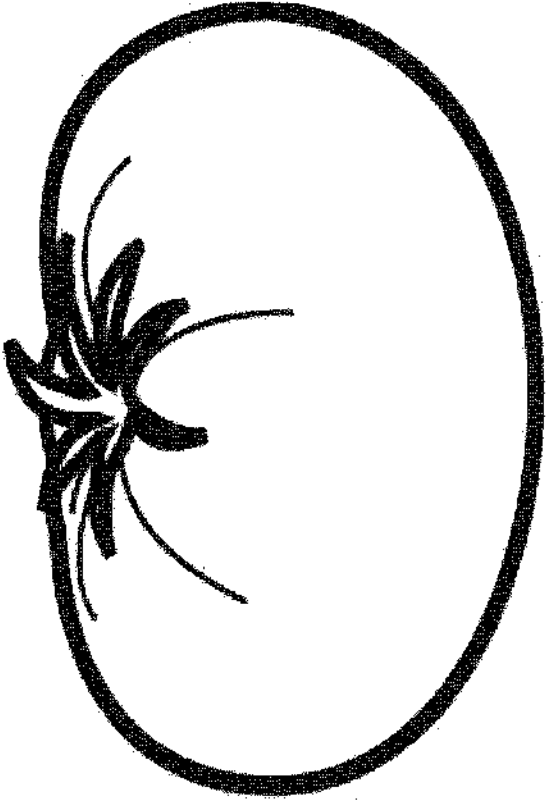

TOMATE

El libro de la letra T, t

NOMBRE:

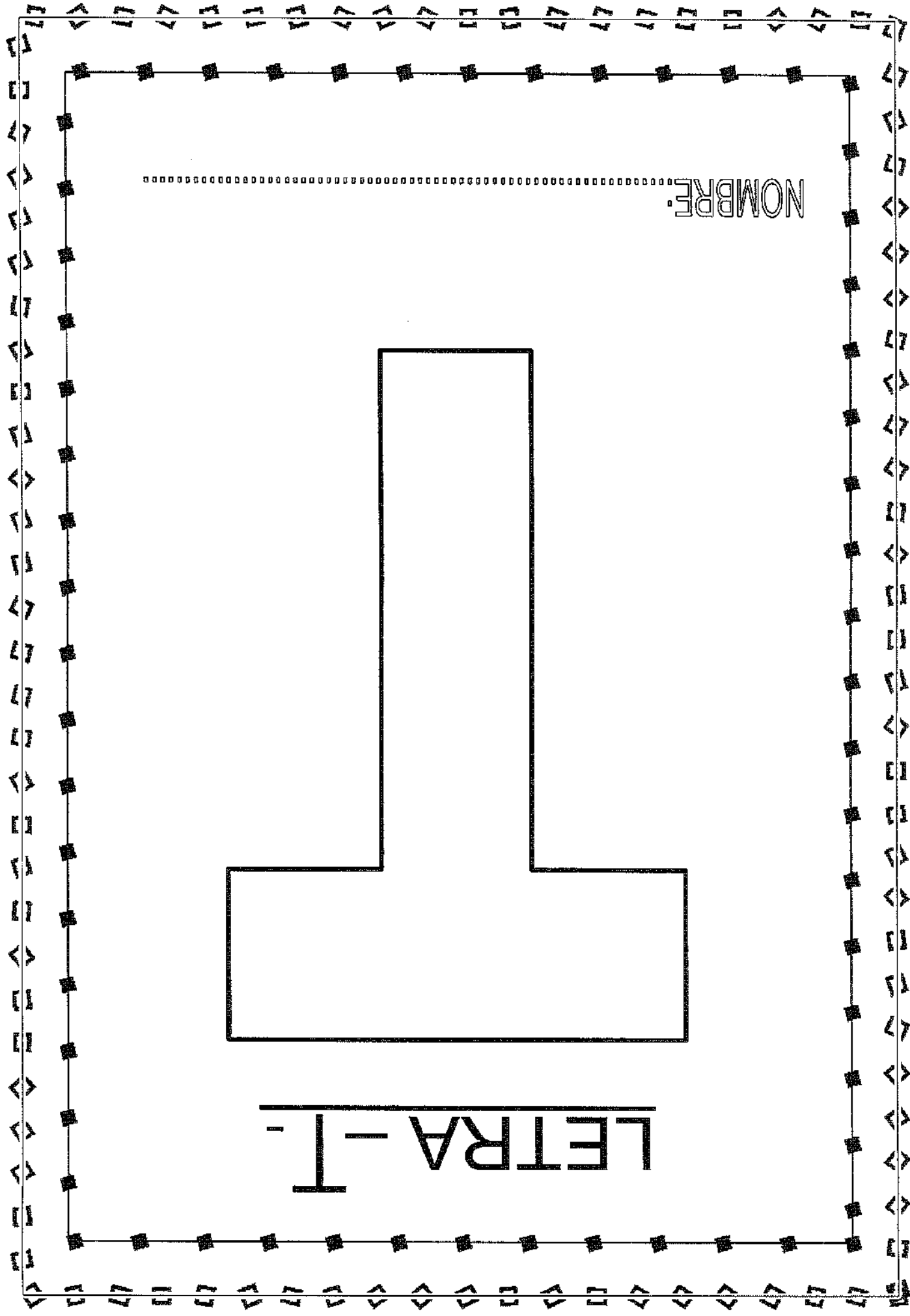

NOMBRE:

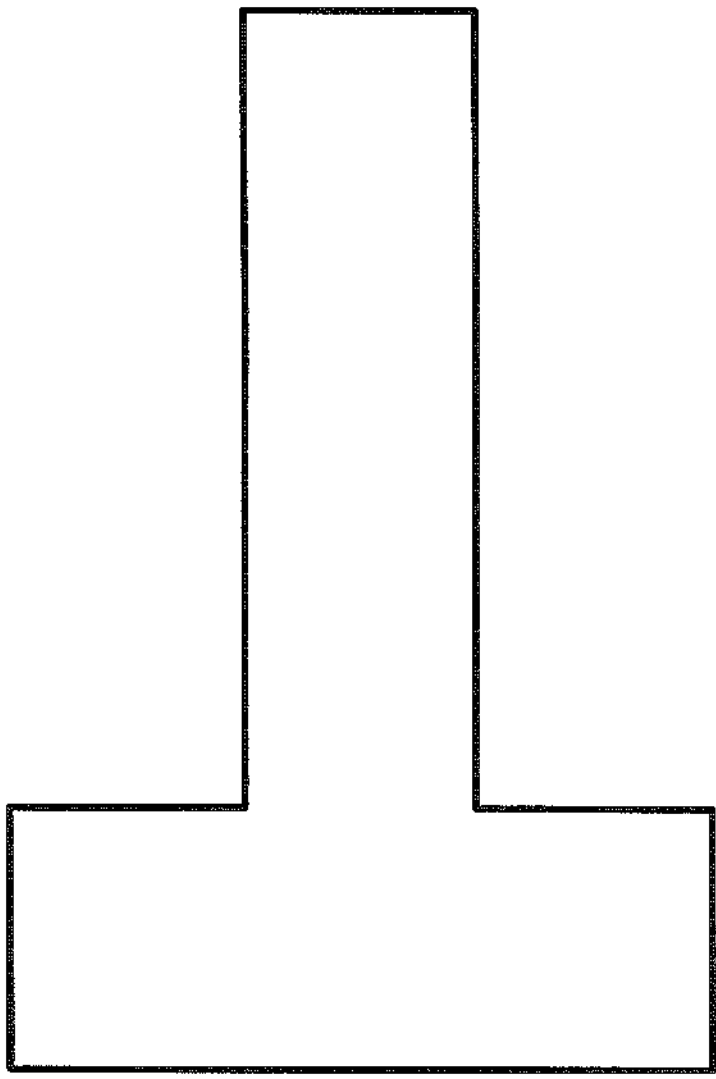

LETRA - T -

COLOREA LA LETRA T

T

P

T

T

S

T

L

S

L

T

M

T

NOMBRE:.....

Colorea las imágenes que contienen la letra T, t.

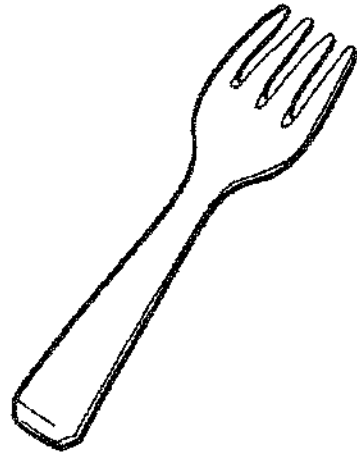
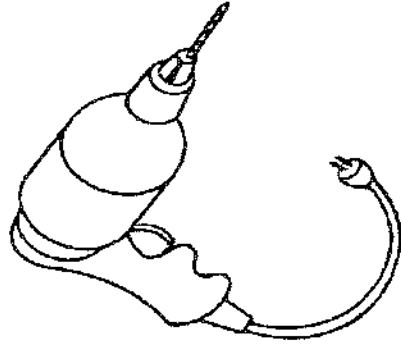
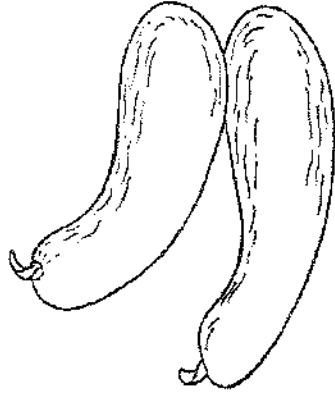
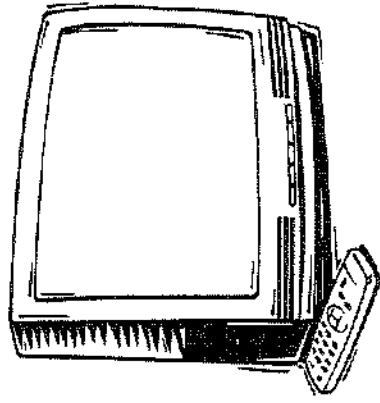
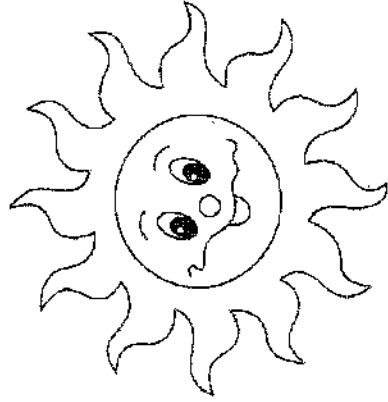

NOMBRE:.....

Realiza el trazo de la letra T - y colorea el dibujo.

T T T T T

T T T T T

T T T T T

T T T T T

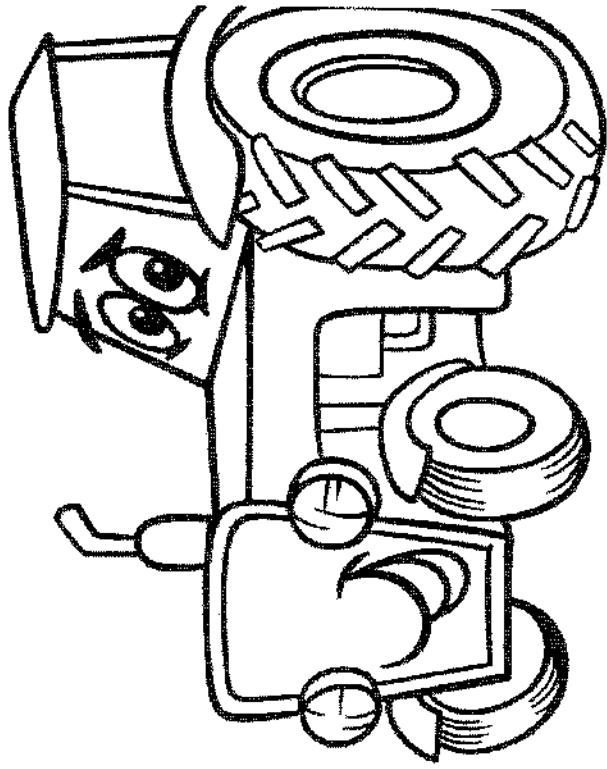

NOMBRE:.....

REPASA LA LETRA "T"

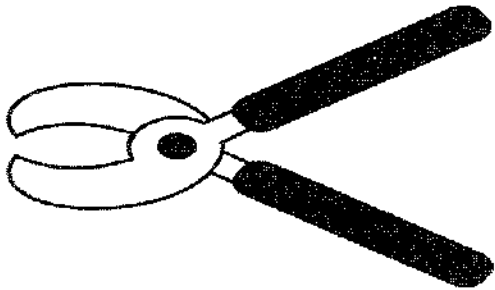
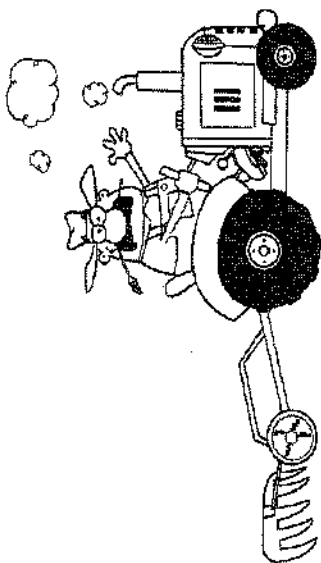

2013

T	T	T	T	T	T	T	T
T	T	T	T	T	T	T	T

NOMBRE.....





ESCRIBO LA LETRA "T"

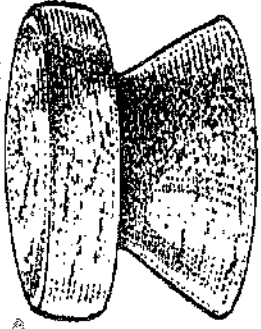
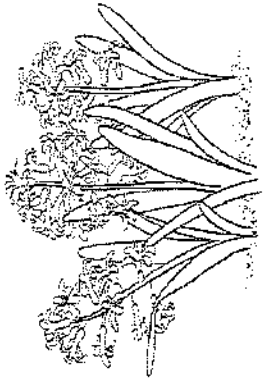

DIBUJO:

NOMBRE:

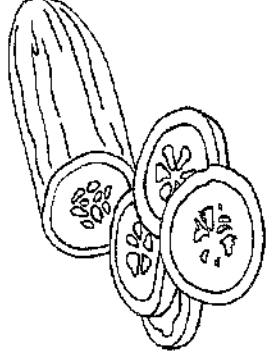
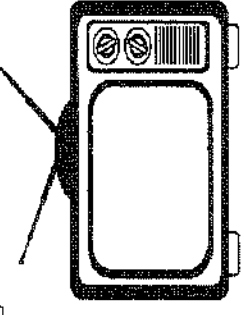
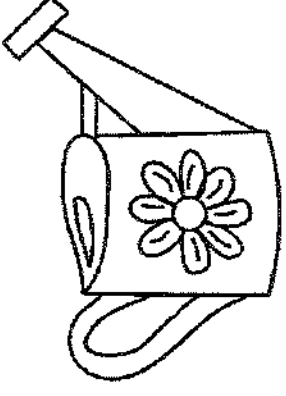
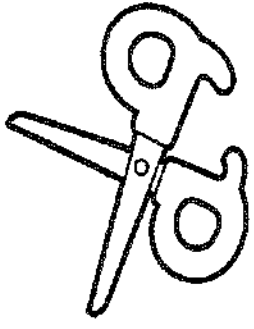
Colorear las imágenes que contengan las sílabas señaladas:

Ta			
Te			
Ti			

NOMBRE:.....

Colorear las imágenes que contengan las sílabas señaladas:

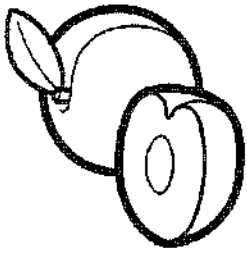
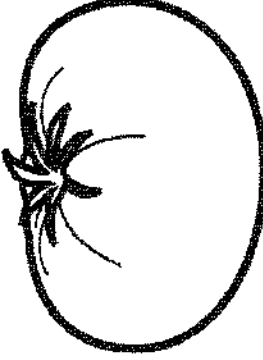
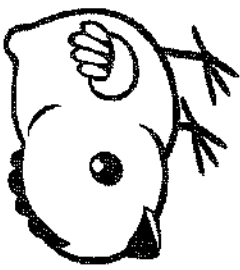
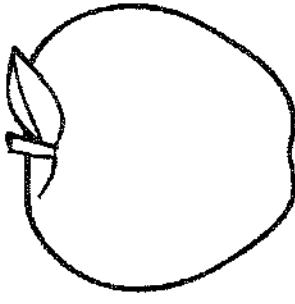
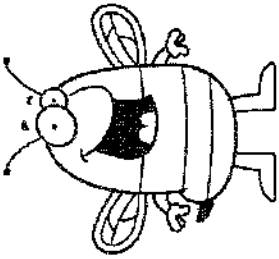
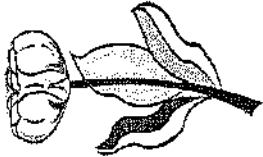
T a			
T u			

NOMBRE:.....

REPASO Y ESCRIBO

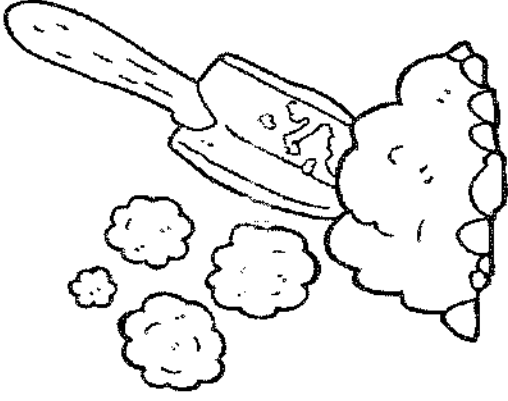
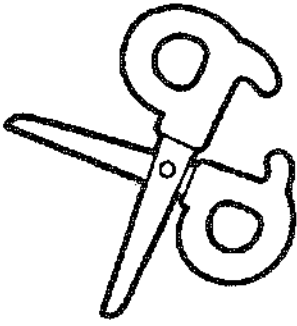
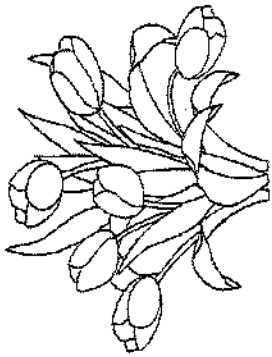

T A T E T I T O T U T A T F

T A T E T I T O T U T A T F

NOMBRE:

NOMBRE:

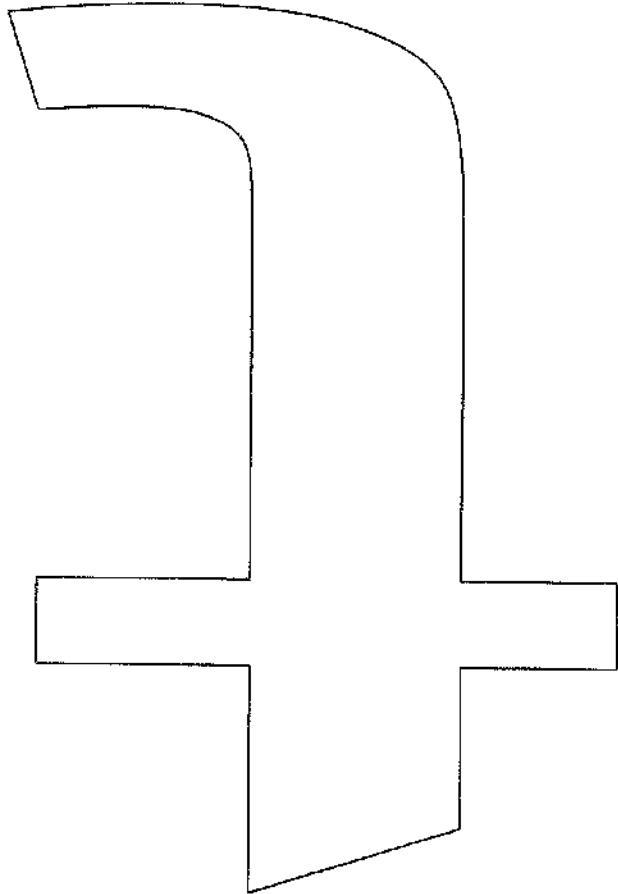

LETRA f

COLOREA LA LETRA -t-

t

t

l

m

n

m

a

t

l

t

t

t

t

NOMBRE:.....

Colorea los dibujos que tienen la letra T, t.

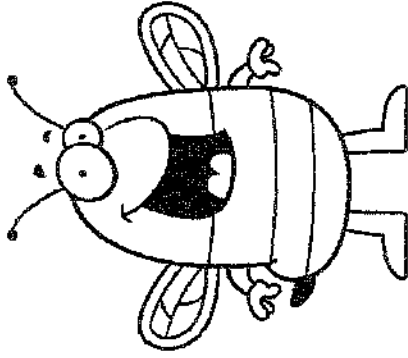
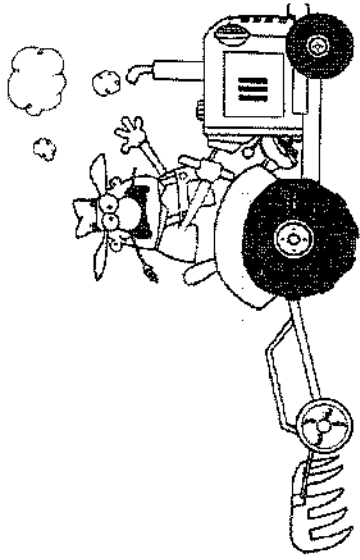
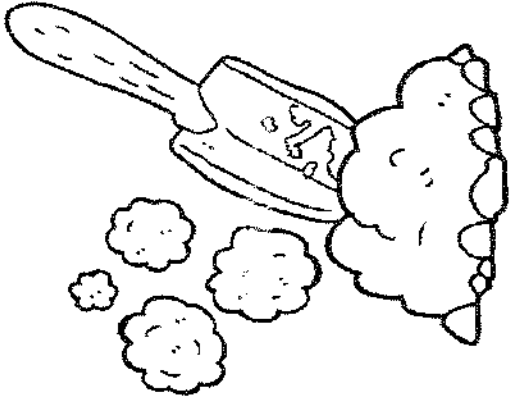
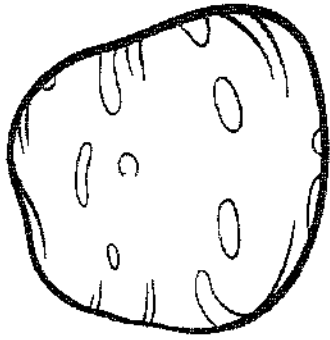

NOMBRE: _____

Realiza el trazo de la letra t- minúscula.

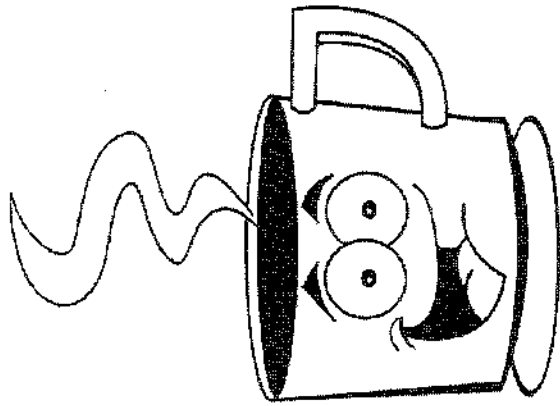
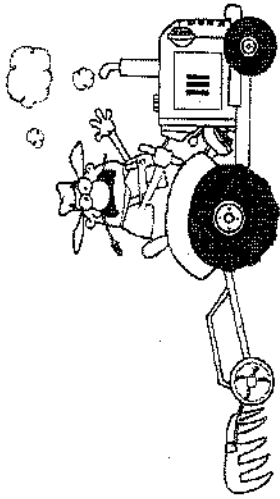

NOMBRE:.....

Colorear las imágenes que contengan el sonido -L/l.

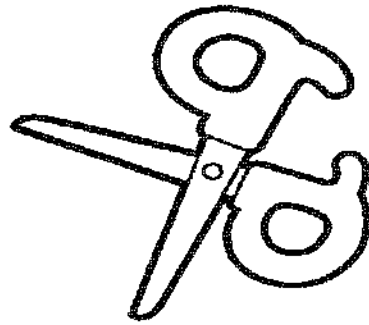
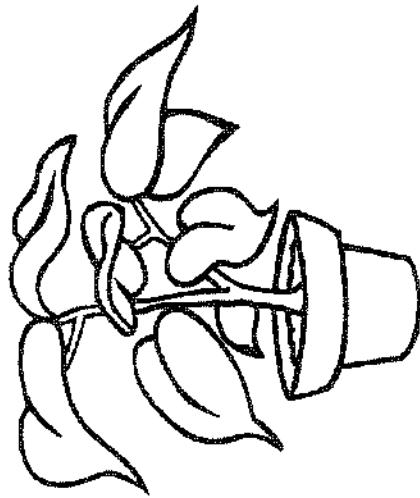
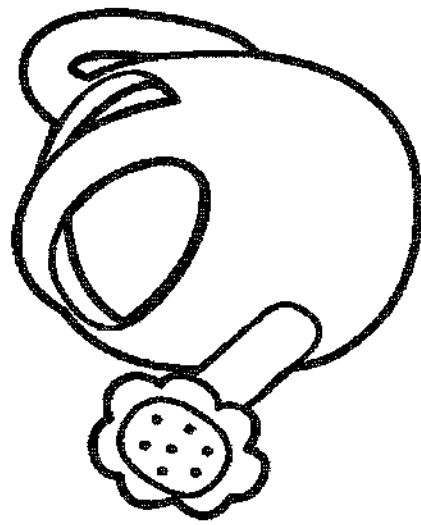
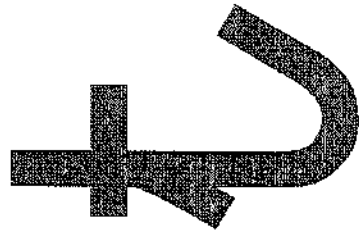
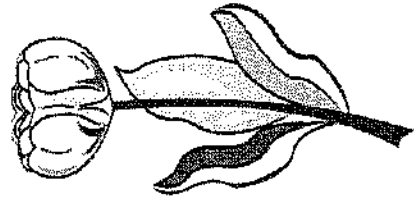
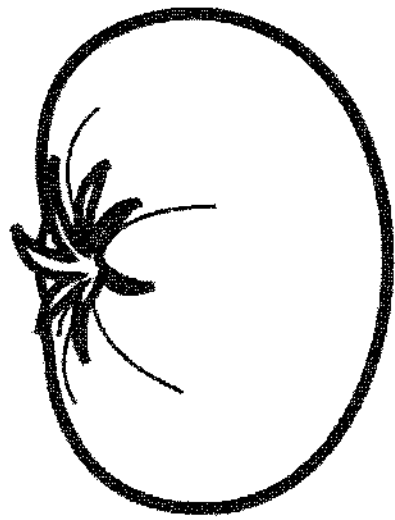

NOMBRE:.....

Colorea la letra T - de rojo y la letra t - de azul.

t

T

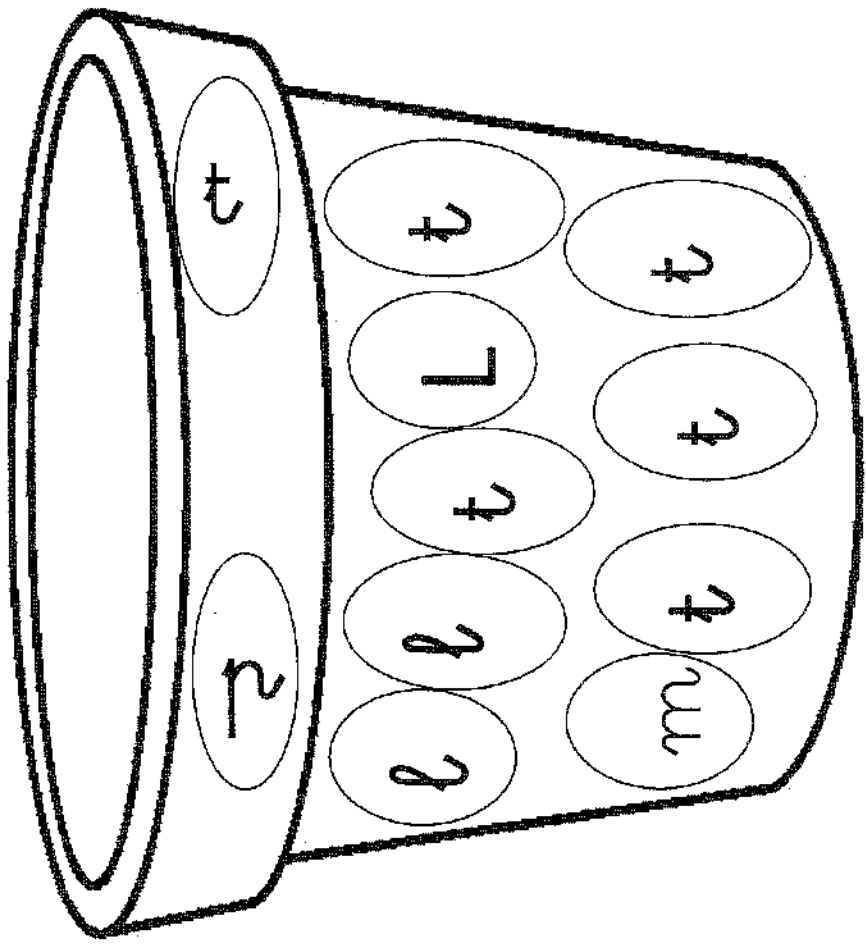
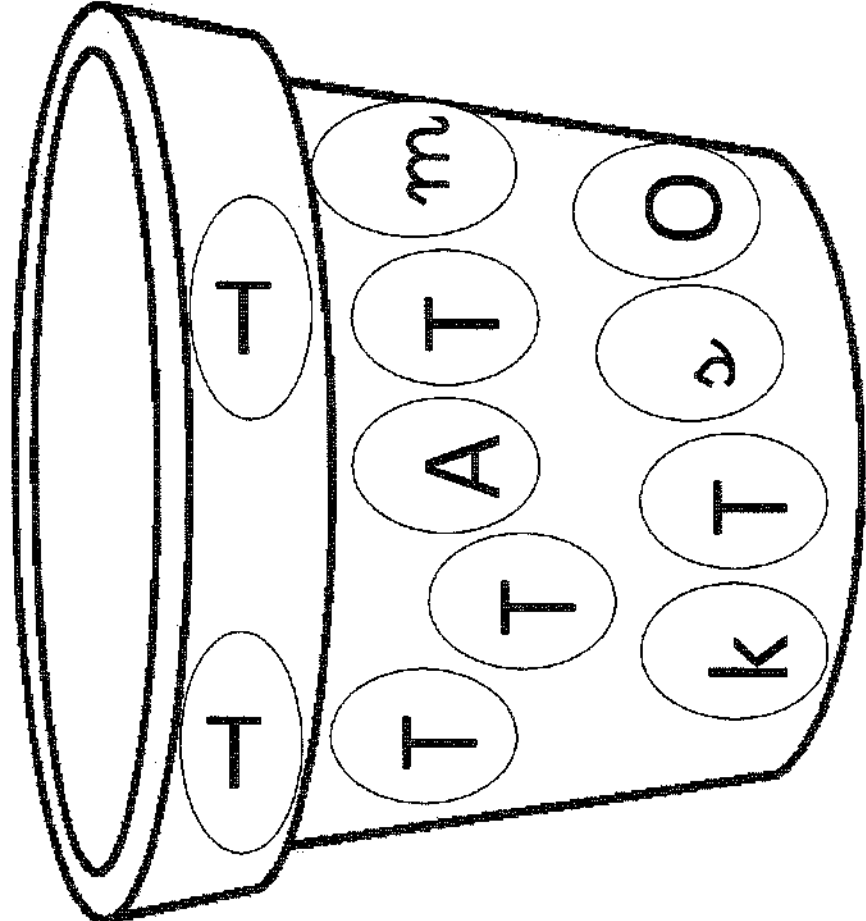

NOMBRE:.....

NOMBRE:



tu

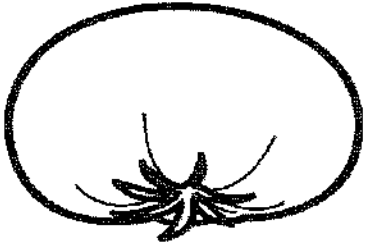

tu

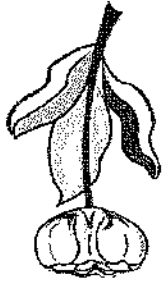

tu

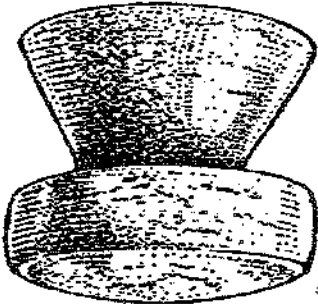

te

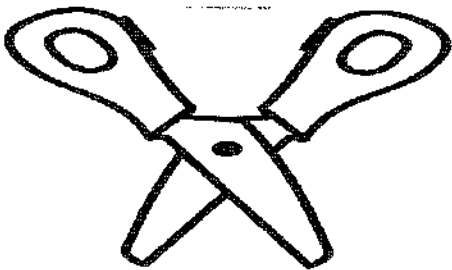

ta

Une com flecha cada sílaba con su dibujo:

REPASO Y ESCRIBO LA LETRA "t"

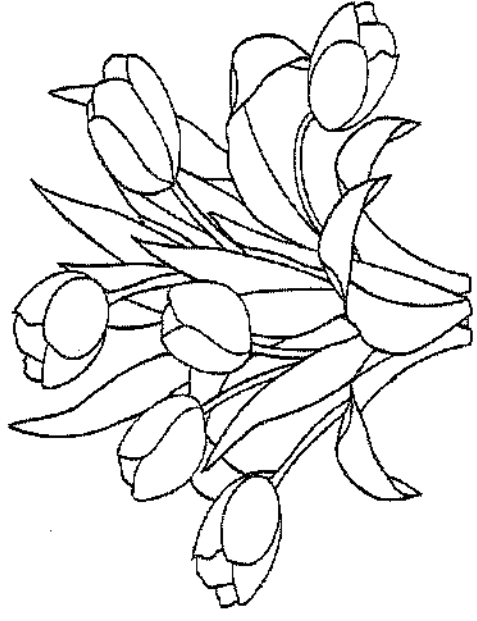
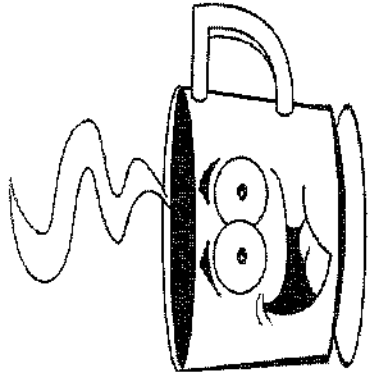

t t t t t t t t t t t t t t t t

t t t t t t t t t t t t t t t t



NOMBRE:

ESCRIBO LA LETRA "t"



DIBUJO:

NOMBRE:.....